

# RockHound.com

## BrushHound

800 426-5615



## 72F BrushHound Owner's Manual





# Delivery Report Form

Prior to acceptance of the equipment, thoroughly check and mark off the items outlined in the delivery checklist below with your sales representative. Make sure you fully understand the operation, adjustment and safety rules as outlined in the operator's manual. The sales representative is responsible for going over this form with the owner and operator of this attachment. This form also serves as your warranty registration. Fax to 360-230-2322.

## Customer Information

Last Name		Street Address	
City	State	Zip	

## Attachment Information

Model	Serial Number
-------	---------------

## Dealer Information

Company Name		Sales Rep. Name	
Company Street Address	City	State	Zip

## Delivery Checklist

- Check to make sure attachment is completely lubricated.
- Buyer is shown all grease fittings and proper daily maintenance routine.
- Buyer is shown correct operation procedures including correct height of attachment.
- All bolts checked for tightness.
- All knives and blade bolts are in place.
- All shields in place.
- Procedures for attaching mower demonstrated to buyer.
- Starting procedures explained to buyer.
- Operation guidelines as outlined in owner's manual explained to buyer.
- Adjustment of cutting height explained to buyer.
- Replacement of knives explained to buyer.
- Hydraulic breaker mode function and case drain application explained THOROUGHLY.
- All safety precautions thoroughly read and understood.

**The signatures below indicate that both the sales representative and the end user have gone over the above checklist and all topics have been covered thoroughly.**

Buyer Signature \_\_\_\_\_ Date \_\_\_\_\_

Sales Rep. Signature \_\_\_\_\_ Date \_\_\_\_\_

**Fax this completed form to 360-230-2322.**



# Table of Contents

## Introduction

Thank You .....	1
Warranty Information .....	2

## Safety

Safety Procedures .....	3
Maintenance Safety.....	5

## Basic Operation

Attaching to Skid Steer .....	6
Starting Procedure.....	7
Running Your BrushHound.....	8

## Adjustments and Maintenance

Lubrication.....	9
Cutting Height and Belt Adjustment.....	10
Replacing the Knives and Skid Shoes.....	11
Cleaning Your Attachment.....	12
Optional Front Caster Wheel.....	13
Transport, Removal and Storage.....	14
Frequently Asked Questions.....	15

## Parts Catalog

Specifications .....	17
Pulley System.....	18
Cutter Drum Assembly.....	19
Gauge Roller Assembly.....	20
Hydraulic Motor.....	21
Hydraulic Plumbing.....	22

# Thank You

Dear Customer,

Thank you for purchasing a **RockHound Attachments BrushHound**. This manual has been prepared to acquaint you with the operation, adjustment and maintenance of your new mower. It was carefully designed and manufactured under the highest industrial standards to give you years of dependable service. Read this manual carefully and fully understand the operation of the machine before attempting to operate it. Each section has been clearly identified so you can find the information you need. **RockHound Attachments** reserves the right to make changes in design and specifications, and/or to make additions to or improvements in its product without imposing any obligation upon itself to install them on its products previously manufactured. If at any time you require additional information, consult your authorized dealer or the customer service department.

## ATTENTION

The safety of the operator was one of the primary concerns of **RockHound Attachments** when designing this mower. Shielding, simple adjustments and other safety features were built into this mower whenever possible. You can make your home, orchard or farm a safer place to live and work if you observe the precautions following this message. Be sure you and the people working for you read and understand them. All machinery should be operated only by responsible persons who have been trained to operate them in a safe manner.



**RockHound Attachments** is solely owned by Valley Tool and Manufacturing.

Have a farm or orchard? Own a tractor with PTO capabilities? Visit our full line of flail mowers at [www.vrisimo.com](http://www.vrisimo.com).

**RockHound Attachments**  
P.O. Box 220-2507 Tully Rd.  
Hughson, CA 95326  
Phone: (800) 426-5615 Fax: (360) 230-2322

## Important to Purchaser Customer Ownership Registration

Prior to acceptance of this attachment, thoroughly check off the pre-delivery checklist with the sale representative. Be sure you fully understand the operation, adjustment and safety rules as outlined in the operator's manual.

### Delivery Checklist

- Check to make sure attachment is completely lubricated.
- Owner is shown all grease fittings and proper daily maintenance routine.
- Owner is shown correct operation procedures including the correct height of the attachment.
- All bolts checked for tightness.
- Front demolition door option was explained.
- All knives and blade bolts are in place.
- All shields are in place.
- Belts checked for proper adjustment.
- Procedures for attaching the attachment demonstrated.
- Starting procedures explained to end user.
- Operation guidelines as outlined in this manual explained to end user.
- Adjustment of cutting height explained to end user.
- Replacement of knives explained to end user.
- Lift limit D-Ring application explained.
- ALL safety precautions thoroughly read and understood.

### Warranty

RockHound Attachments guarantees the BrushHound Mower to be free from defect in material and workmanship for a period of six months dating from delivery to the original user. The obligation under this warranty, statutory or otherwise, is limited to the replacement and/or repair at your authorized RockHound dealer of such part or parts as shall appear to us, upon inspection, to have been defective in material or workmanship and not altered in any way by the customer or other parties.

This warranty shall not apply to vendor warranted items such as bearings, belts and gearboxes or other parts not manufactured by RockHound Attachments. Such being subject to the warranty of their respective manufacturers.

No expressed, implied or statutory warranty other than herein set forth is made or authorized to be made by us. RockHound Attachments shall not be liable for consequential damages of any kind, including but not limited to: consequential labor costs or transportation charges in connection with the replacement or repair of defective parts, lost time or expense which may have accrued because of said defects.

RockHound Attachments reserves the right to make changes in its products at any time and without prior notice. When such changes are made, neither RockHound Attachments nor its dealers assume any obligation to make these changes in products previously manufactured.

# Safety

**Failure to heed these warnings may result in personal injury or death.**

- Before operating this machinery read the owner's manual carefully.

- Use OSHA approved eye, ear and head protection to protect the operator from any flying debris and noise.



- All personnel except operator should be 100 feet clear of machinery before starting or operating it.

- Never use drugs or alcohol before or while operating your attachment.



- Be aware that operating equipment for an extended period of time can result in fatigue or boredom and may cause the operator to lose awareness of what he/she is doing. It is recommended that scheduled work breaks be taken to avoid this.
- Keep hands and loose clothing away from any power-driven parts.
- Avoid contact with hot surfaces including pumps, motors, hydraulic oil tanks and hose connections.
- Do not operate this machine without all guards being in good condition and firmly in place.
- Do not operate this machine on a skid steer or excavator that is not properly maintained. If a control failure should occur while operating this machine, immediately shut it down and perform repairs before continuing.
- Be aware of the cutter drum rotation direction and do not let bystanders stand to either side of the mower.
- Under no circumstances should the blades of this attachment contact the ground or be curled up to where they are visible to the operator. Serious injury or death can occur.
- Always walk the area to be worked to insure the jobsite is free of obstacles and debris that could injure the operator or damage the machine.



## Safety (cont.)

- Stop the operation of this machine when people or vehicle driver's vision becomes obscured, caused by the discharge of materials and dust. Also avoid operating this attachment in unusually foggy or dusty conditions or at night.
- Never leave the attachment unattended while it is in the lifted position.
- Keep away from rotating elements to prevent entanglement.
- Listen for blades to completely stop prior to dismounting machine.
- Do not let the blades turn while the deck is raised for any reason.
- Use flashing warning lights when operating on highways, except when prohibited by law.
- Be aware that the attachment may be wider than the operating vehicle and caution should be used to avoid clipping or running over trees, signs or posts that may be in the way of the attachment.
- Never allow children or other persons to ride on the attachment.



- Drive at a speed you can safely operate the vehicle and attachment. Normal ground speed ranges from 0-5 miles per hour. Use slow speeds when operating on or near slopes, ditches, drop-offs, or when debris and foreign objects are to be avoided.
- Use the following guidelines to reduce the risk of equipment and grass fires:
  - Do not smoke or have an open flame near the operating vehicle or attachment.
  - Do not drive into burning areas or areas that have been freshly burned.
  - Insure slip clutches and/or belts are properly adjusted to avoid excess heat.
  - DO NOT allow clippings or debris to collect near hydraulic motors and gearboxes.
- Do not position the attachment or turn it so sharp that the hoses could get pinched or squeezed.

# Maintenance Safety

- Be sure to inspect all safety devices (including safety shields, guards, deflectors, etc.) before each use.

## Safety Device Examples



- Maintain all safety decals and make sure they are visible to the operator. If decals are worn, contact your nearest RockHound dealer for replacements.
- Replace bent or broken blades with new ones. Do not attempt to weld or bend damaged blades. This can cause cracking or other types of damage that could result in the blade being thrown from the mower.
- Wear gloves and eye protection and exercise care when handling blades. Also be alert to worn or damaged surfaces that could have sharp edges.
- Disengage hydraulics and shut off engine, allowing all movement to stop before leaving the operator's position to adjust, lubricate, clean or unclog the machine.
- Replace rubber guard on the front of the mower if torn, frayed, punctured, or worn before operating this equipment.
- Before working on or underneath the attachment, place blocks on both sides (front and back) of operating vehicle tires or treads and under each end of the attachment to prevent accidental lowering of the machine. Also remove the ignition key from the operating vehicle and allow all movement to stop before beginning work.

# Basic Operation

## Attaching to Skid Steer

The BrushHound 72F can be attached to any skid steer with a front mount universal skid steer style mounting plate.

### ATTENTION

**Make sure all hydraulic hoses are clear of the front mounting plate before connecting the attachment.**

1. Line the mount on the skid steer up with the universal mount on the mower.

Skid Steer Mounting Plate

Mower Mounting Plate

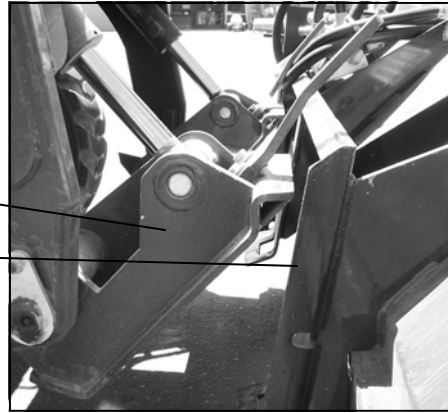

2. Lower the mount on the skid steer and tilt it forward so that it can “scoop” up under the mounting plate on the mower.
3. Slowly move the skid steer forward until it taps against the mower.
4. Raise the front mount up on the skid steer and tilt backwards.
5. Check the bottom portion of the mount to see if the mounting plate on the skid steer is flush with the mounting plate on the mower.
6. Lower the locking mechanisms on the skid steer until they are in a horizontal position. Be sure that locking levers are through the bottom plate. (Item 1)

7. Attach hydraulic hoses on the skid steer by pressing inward until they lock in place. Note: It is easier to attach hoses when machine is off.

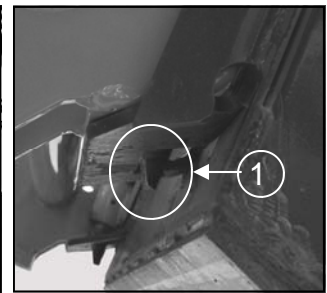
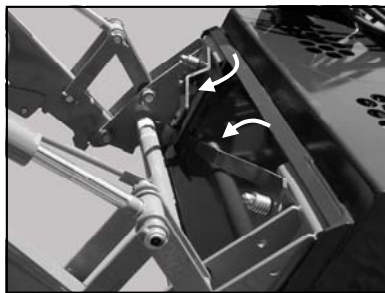

# Basic Operation

## Starting Procedure

### ATTENTION

Do not start the operating vehicle until mower has been carefully checked for correct assembly and installation. Be sure all observers are at least 100 feet clear of the machine.

1. Check to see that the mower is in the down position and blades are not touching the ground. Start the engine. Set throttle at idle speed.

### WARNING

**DO NOT engage auxiliary flow hydraulics at a high engine speed.**

2. With low RPM, turn on the auxiliary flow hydraulics.
3. Slowly bring up the RPM to maximum flow/efficiency.

**IMPORTANT: Should excess vibrations occur, disable auxiliary hydraulics and shut the machine down immediately. Determine and correct the problem before continuing work.**

4. When work is finished, disable auxiliary hydraulics, shut off operating vehicle, set parking brake and check hydraulic motor, motor protection valve and other areas for excess heat or leaks. Do not touch the motor or other hot areas with bare skin.

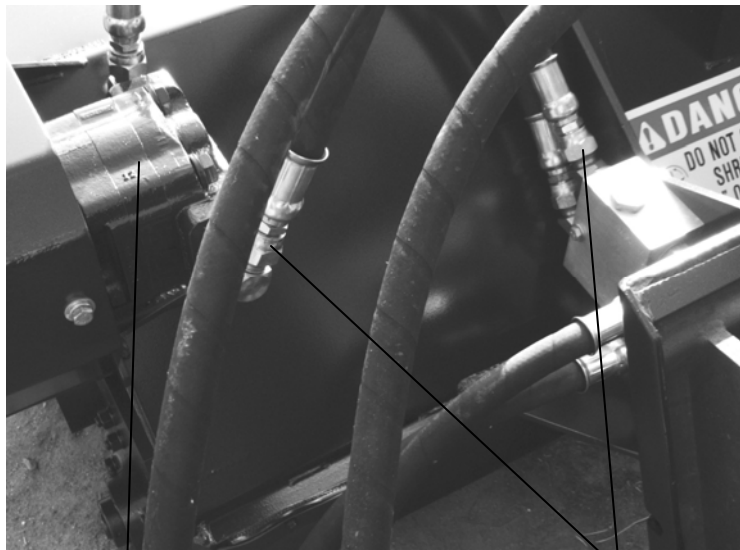

Check Motor  
for Excess Heat

Check Hose Fit-  
tings for Leaks

# Basic Operation

## Running Your BrushHound

1. Ground speed should range anywhere from 0-5 miles per hour. However, the operator should drive at a speed he or she is comfortable with within this range.
2. The sides of the mower should be level with the ground while it is running.
3. The weight of the mower should be on the gauge roller, which runs on the ground.
4. This mower can be raised slightly to mulch larger brush, but never high enough to where the blades are exposed to the operator. Never push against the front of the mower or caster wheel.
5. If your BrushHound has the optional skid shoes, make sure they are not running on the ground. They are made only to collide with small hills, mounds or other uneven surfaces and are not made to run on the ground.
6. Cutter drum rotations can be reversed to one of two directions. The first is the re-cut direction. The cutter drum with this application rotates opposite to the wheel direction. This application is designed to cut the material more than once, but requires more horsepower and a lower ground speed. The second is the one-cut direction. The cutter drum on this application will rotate the same direction as the operating vehicle tires. The material will only be cut once but you can run at a higher ground speed and it requires less horsepower.



**Gauge Roller Running  
on Ground**

**Skid Shoe Elevated**

# Adjustments and Maintenance

## ATTENTION

Before doing any service work, observe the following safety rules:

1. Allow all movements to stop before leaving the operator's position to lubricate or clean the machine.
2. Before working on or underneath the mower, place blocks on both sides of the operating vehicle tires or treads and under each end of the mower to prevent accidental lowering of the machine.
3. Remove the ignition key from the operating vehicle and allow all movements to stop before beginning work.

## Lubrication

1. GREASE DAILY: Four Bearings. The cutter drum bearing is located behind the pulley.

## CAUTION

Over-greasing seals and bearings can cause damage. If an excessive amount of grease comes out, too much grease has been applied.

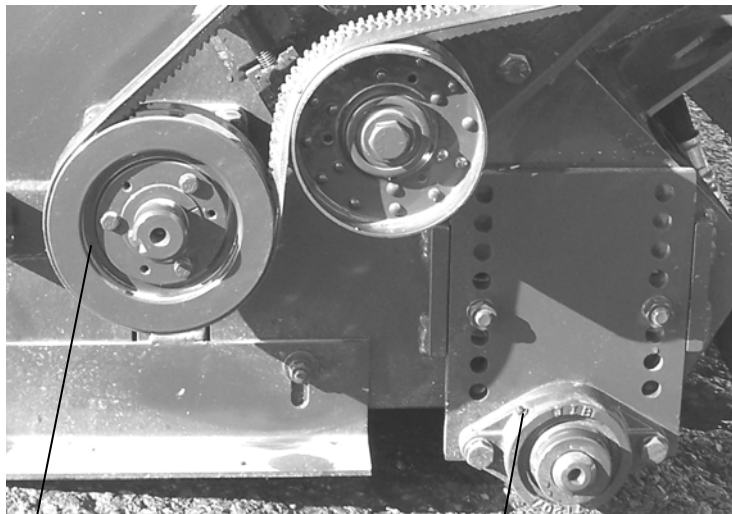

Main Cutter Drum Bearings

Back Gauge Roll Bearings

# Adjustments and Maintenance

## Cutting Height, Skid Shoes, and Belt Adjustment

1. The cutting height of the mower can be adjusted from 0-6". Adjustment is done by adjusting the height of the gauge roller on the side of the mower that is closest to the operating vehicle and then adjusting the tilt on the operating vehicle so that the desired cutting height is achieved.
2. Adjusting the height of the back gauge roller is done by removing the two bolts on the height adjusting plate on both sides of the mower and sliding the plate up or down to achieve the desired height. The weight of the mower should be on the gauge roller, not on the front.
3. Belt adjustment is done by tightening the idler adjusting rod, which pulls the idler pulley into the belts. On a new machine, after 1-2 hours of operation, tighten the drive belts so there is only 1/4" to 3/8" give with 8 pounds of force.
4. Replacing or installing skid shoes is done by removing the two bolts holding them in place and simply reinstalling new ones using the two bolt holes that the old ones were removed from.
5. Adjustment of the height limiter is done by increasing or reducing the amount of slack in the chain going from the ring on the shredder to the ring on the operating vehicle. More slack will allow the machine to be raised higher and less slack will keep it lower to the ground.

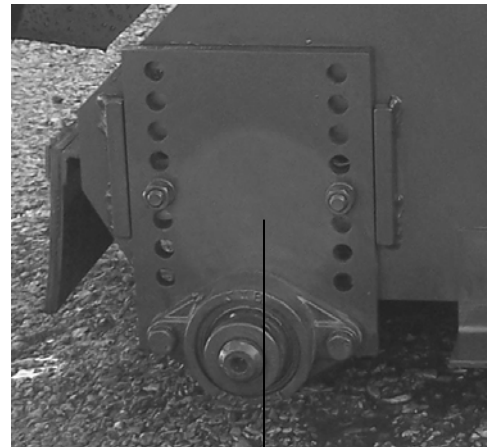

**Gauge Roller Adjustment**

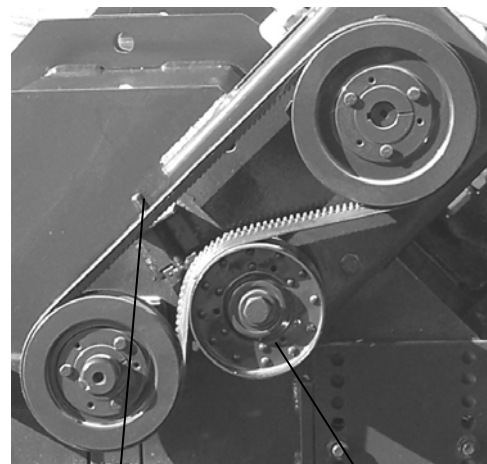

**Idler Adjusting Rod**

**Idler Pulley**



**Remove Two Bolts**

# Adjustments and Maintenance

## Replacing the Knives and Skid Shoes

1. When knives, bolts or spacers become worn, they must be replaced. Not doing so could cause the cutter drum to run out of balance.

### ATTENTION

**An unbalanced cutter drum can result if new knives or parts are mixed with worn parts. Wear gloves at all times when handling knives.**

2. Replacing the knives is done by disconnecting the mower and tipping it up on its front end. Remove both skid shoes by removing the bolts holding them in place. Look in the gap created by the skid shoe on the side where the pulley system is located and remove the cotter pin that is inserted into the end of the hanger rod. Go to the other side and pull the rod out. The knives should drop out.
3. Once the knives have dropped out, replace with new ones by pushing the rod in while someone holds the new knives in place.
4. Install cotter pin and re-install skid shoes.

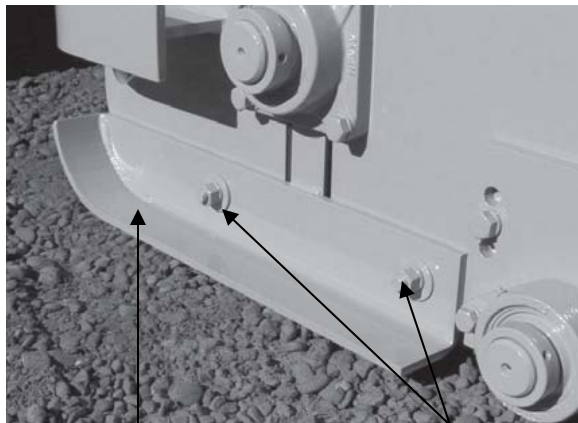

Skid Shoe

Remove



Industrial Knife

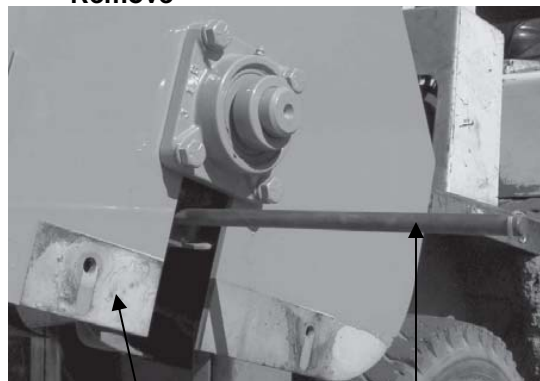

Skid Shoe Area

Hanger Rod



# Adjustments and Maintenance

## Cleaning Your Mower

### ATTENTION

To preserve life of paint and decals, wash the mower after each use. The preservation of your mower's decals is essential to safety, so make sure they are kept in good condition.

It is recommended that some sort of degreasing solution be used on all bearings.

1. Check for excess grease in bearing areas on the pulley side of the mower. Make sure that grease is not allowed to get into the belt areas.
2. Clean clippings from hydraulic hose areas, mounting areas or any other areas that may be susceptible to excessive heat.

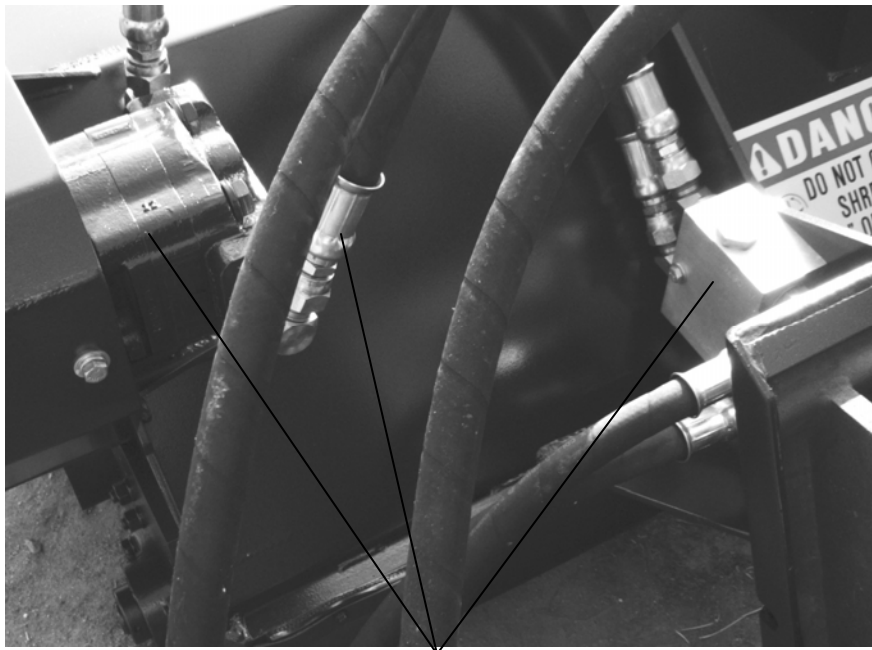

**Check hose areas and mounting areas for clippings.**

3. Clean the inside of the mower with a pressure washer. Make sure the inside of the mower is kept free form mud and compact grass. Keep in mind that mud built up on the cutter drum can cause imbalance.
4. Preserve damaged decals or replace them if they are unreadable. Decal kits can be obtained from your local RockHound dealer.
5. Check for worn or damaged hydraulic hoses and replace when needed.

# Adjustments and Maintenance

## Optional Front Caster Wheel

1. The front caster wheel is an optional height adjustment tool that can be added at any time. It is made to work in conjunction with the back roller in order to adjust the height of the mower. This wheel helps to provide a highly regulated height of cut.
2. The wheel is a Category 0 size attachment that has three attachment points on the mower.
3. There are two attachment points that require pins and two that require bolts as shown in the photo.



**Hitch Pins**

**Turnbuckle**

4. Adjustment is done by turning the turnbuckle and setting the jam nut on the bottom of the turnbuckle to the minimum height you want to allow. From there you can easily turn the tube to extend it.
5. Extending the turnbuckle will raise the mower off the ground and tightening it will lower the height of the mower.

# Transport, Removal and Storage

## ATTENTION

Shut off the engine allowing all movement to stop before leaving the operator's position to adjust, lubricate, clean or unclog the machine. Before working on or underneath the mower, place blocks on both sides (front and back) of operating vehicle tires and under each end of the shredder to prevent accidental lowering of the machine. Also remove the ignition key from the vehicle and allow all movement to stop before beginning work. To transport, disengage auxiliary hydraulics and lower the machine to a reasonable ride height.

## Removal

1. Lower the mower all the way onto the ground.
2. Unlock the locking devices on the operating vehicle mount.
3. Tilt the operating vehicle mount so the bottom of the mount comes inward and lower the mount of the vehicle so that it disconnects from the mower.

## Storage

1. Clean the mower thoroughly.
2. Relax belt tension.
3. Lubricate the mower as outlined previously.
4. Check hoses and replace if damaged.
5. Check for worn parts and replace so you will be ready to operate when necessary.
6. Store in a clean, dry place.

## Frequently Asked Questions

Q. Where is the serial number for my machine?

A. The serial number for your mower is stamped into the mower shield directly in front of the hydraulic motor.

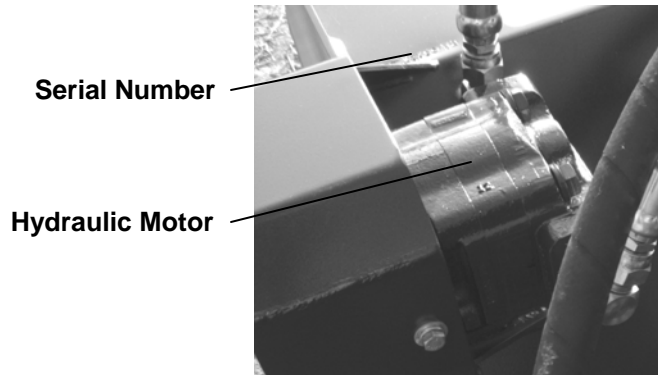

Q. Where do I find replacement parts?

A. First check your local dealer and if they do not have the parts, ask them to order from the RockHound factory.

Q. How often should I change my knives?

A. Replacing the cutting knives is entirely up to the owner. When the cut begins to be inconsistent or rough, consider replacing the knives. It is recommended to keep an extra set of knives on hand so that loss of work time is minimal.

Q. How often should I replace my belts?

A. If you are experiencing repeated slipping, excessive heat or breaking of belts, try adjusting the level of tension. If this does not remedy the problem, replace the belt. Consider having an extra belt on hand as well.

Q. Do I need to fill the hydraulic motor with fluid before I use the mower?

A. No, this does not apply to the F series machine. Attachments are tested at the factory prior to shipment and are full of high quality hydraulic fluid.

Q. What do I do if my belts are wearing out too fast and burning up?

A. First check belt tension. Belts should have about 3/8" sway in them. Adjust tension accordingly. If this does not help, check the height of the grass you are mowing. If the grass is over two feet in height, you might have to adjust the mower cutting height upwards and slow the speed of travel to reduce belt slippage.

Q. How can I prevent my hydraulic hoses from coming off during operation?

A. Be careful! Make sure the hoses are pressed all the way in their corresponding fittings on the operating vehicle. Turn the female coupler collar past the bump to cock. Give them a slight tug to make sure they are on all the way.

## Frequently Asked Questions

- Q. When I am replacing hydraulic fluid, how much should I add?
- A. Consult your power unit's maintenance manual for fluid levels and information.
- Q. Are there any advantages to reversing cutter drum rotation?
- A. Whether or not reversing the cutter drum rotation is advantageous depends on the application. There are two main advantages to reversing cutter drum rotation and those are knife preservation and safety. As time goes on, knives wear down. If the cutter drum rotation is reversed, the knives will be cutting with their other side. As far as safety, the owner has to take into account many things such as whether or not it's safe to have things thrown in the direction of the operator (not recommended). The most important thing is safety, and if the owner decides to reverse cutter drum rotation, it is their responsibility to make sure that it is safe. However, RockHound Attachments recommends running the cutter drum in the reverse rotation (opposite tire rotation) so that shredded material is kept away from the operator.
- Q. How do I reverse cutter drum rotation?
- A. To reverse cutter drum rotation, simply take the two hoses coming from the motor protection valve to the hydraulic motor and switch them.

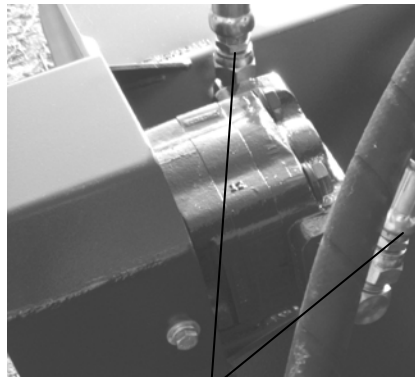

Switch Here

- Q. How do I replace my knives?
- A. Refer to the Adjustments and Maintenance Section for a detailed explanation on how to replace your knives.
- Q. When connecting my hydraulic hoses, is there a specific way they should be attached or can any hose go to any fitting on the operating vehicle?
- A. You will notice that one hose has a female end and the other hose has a male end. The female hose attaches to the male fitting on the operating vehicle and the male hose attaches to the female fitting on the operating vehicle.

# Parts Catalog



## 72F BrushHound

### 72F Specifications

Model	Cutting Height	Cutting Width	Overall Width	Scoop Knives	Industrial Knives	Gauge Roller Dia.	Drive Belt	Weight
72F	0-6"	70"	80"	33	66	1 1/4"	2/Banded	745 lbs.

**Pulley System**

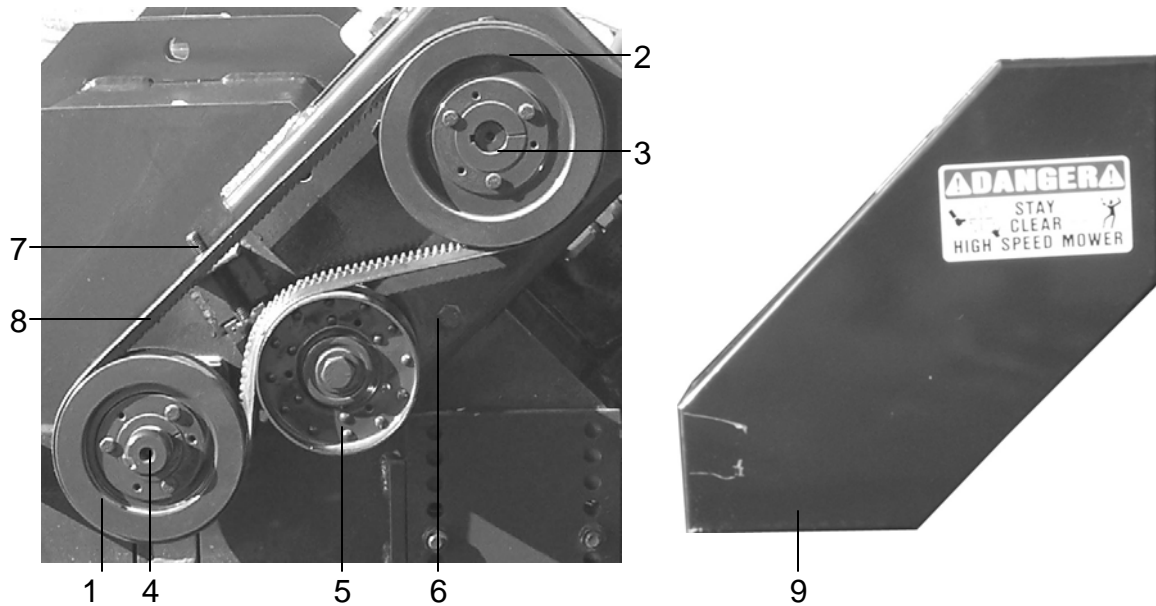

#	Description	Model	Part #	Qty.	Year
1	Lower Pulley, 2 Groove 5.95" OD	72F	P-123	1	2005+
2	Upper Pulley, 2 Groove 6.75" OD	72F	P-124	1	2005+
3	Retainer Bushing 1" ID	72F	TL-139	1	2005+
4	Retainer Bushing 1 7/16" ID	72F	TL-137	1	2005+
5	Idler Pulley	72F	IP-145A	1	2005+
6	Idler Arm	72F	IP-146A	1	2005+
7	Idler Arm Adjusting Rod	72F	IP-147A	1	2005+
8	Banded Belt, 2 Groove	72F	B-155A	1	2005+
9	Drive Belt Cover	72F	B-158	1	2005+

### Cutter Drum Assembly

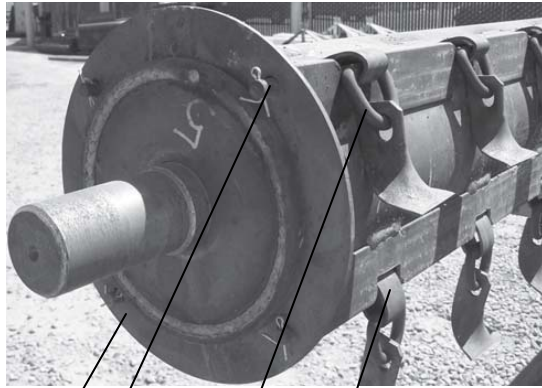

1 2 4 3



8



7 5 6

#	Description	Model	Part #	Qty.	Year
1	Bare Cutter Drum 1 7/16" Shafts	72F	CD-167	1	2005+
2	Hanger Rod-70"	72F	CD-173	2	2005+
3	Oval Hanger	72F	CD-2120	A/R	2005+
4	D Ring	72F	CD-2135	A/R	2005+
5	Scoop Knife	72F	CD-2110	A/R	2005+
6	Industrial Knife	72F	CD-2100	A/R	2005+
7	Thatching Knife	72F	CD-2115M	A/R	2005+
8	Bearing Assembly 1 7/16" Bolt	72F	CD-2116	2	2005+



**Gauge Roller Assembly/Miscellaneous**

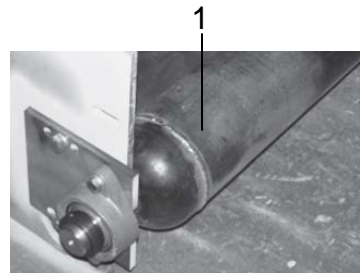

#	Description	Model	Part #	Qty.	Year
1	Rear Gauge Roller 1 1/4" Shafts	72F	BR-202A	1	2005+
2	Bearing Assembly 1 1/4" 2 Bolt	72F	BR-207	2	2005+
3	Height Adjusting Plate	72F	BR-208A	2	2005+
4	Skid Shoe Right Side	72F	S-225	1	2005+
4	Skid Shoe Left Side	72F	S-226	1	2005+
5	Rubber Belting (Per ft.)	72F	RB-1700	A/R	2005+
6	Belt Clamping Strip (Per ft.)	72F	RB-1701	A/R	2005+
7	Self Tapping Screws	72F	RB-1702	A/R	2005+

## Hydraulic Motor Assembly

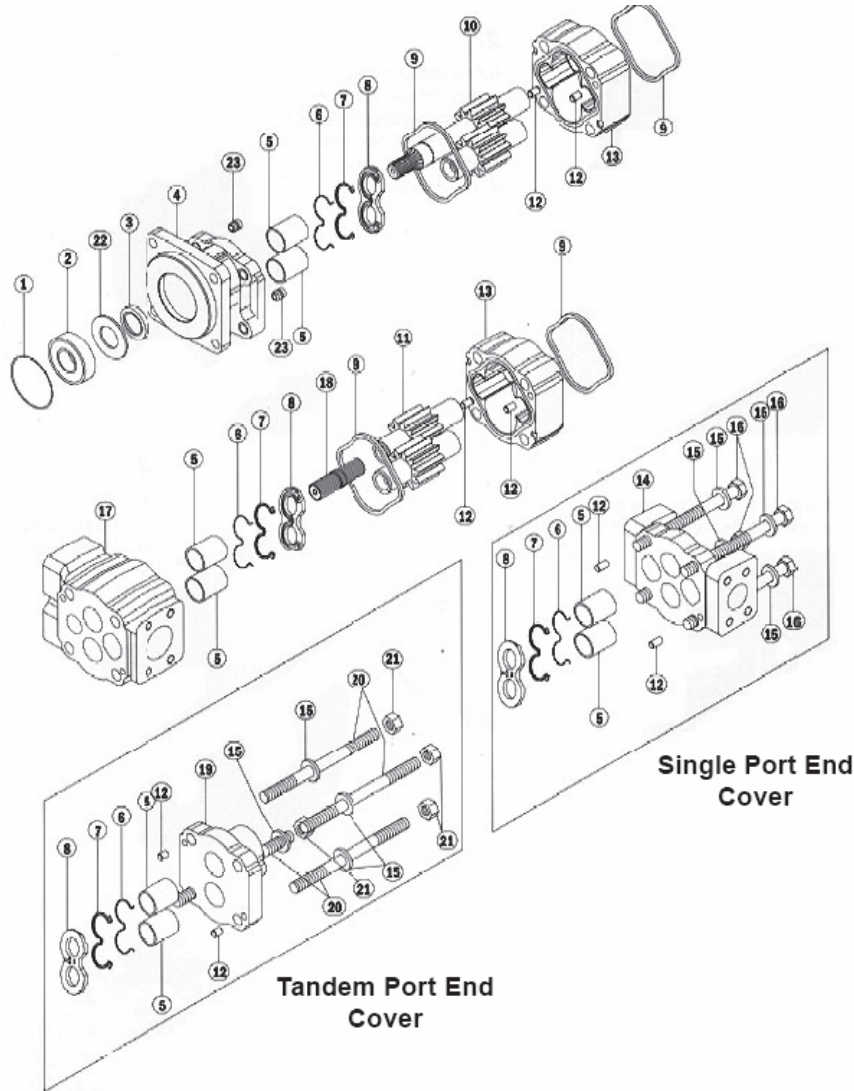

### 330 Series Motor

- |                                |                                     |
|--------------------------------|-------------------------------------|
| 1. Spirolox Retaining Ring     | 13. Gear Housing                    |
| 2. Outboard Bearing (Optional) | 14. Port End Cover                  |
| 3. Shaft Seal                  | 15. Washer                          |
| 4. Shaft End Cover             | 16. Hex Head Bolt                   |
| 5. Journal Bushing             | 17. Bearing Carrier                 |
| 6. Backup Ring                 | 18. Connecting Shaft                |
| 7. Seal Ring                   | 19. Port End Cover                  |
| 8. Thrust Plate                | 20. Tie Bolt                        |
| 9. Housing Gasket              | 21. Hex Nut                         |
| 10. Integral Gear Set          | 22. Spacer (Motor Only)             |
| 11. Continental Gear Set       | 23. Check Valves or Plug (257 only) |
| 12. Dowel Pin                  |                                     |

## Hydraulic Plumbing

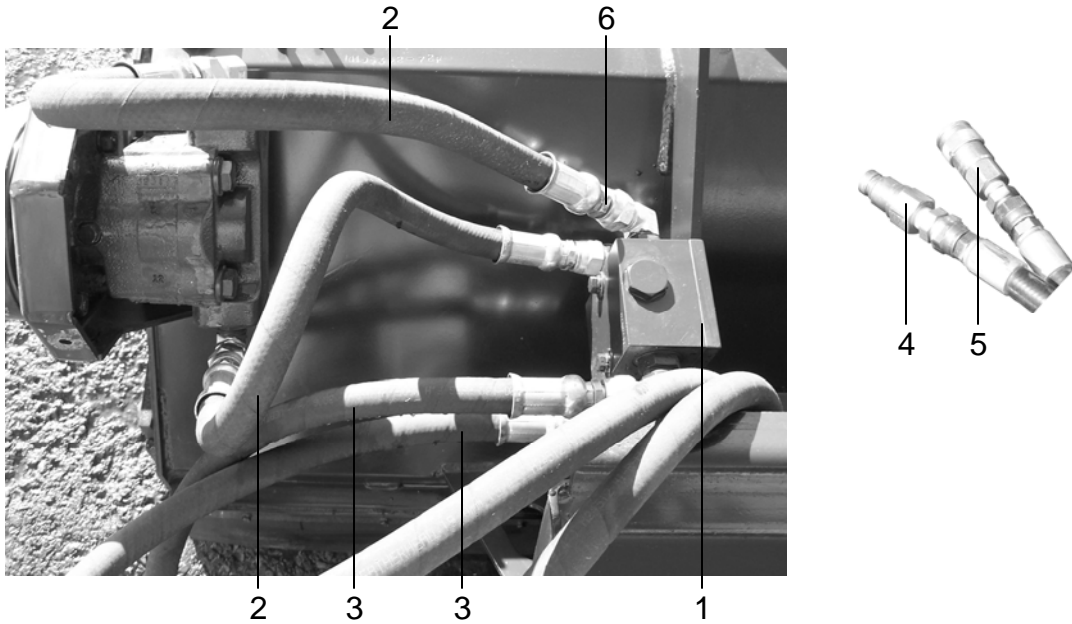

**To reverse cutter drum rotation, reverse the hoses at the motor.**

#	Description	Model	Part #	Qty.	Year
1	Motor Protection Valve	72F	HY-2450	1	2005+
2	Hydraulic Hose 30"	72F	HY-2560	2	2005+
3	Hydraulic Hose 72"	72F	HY-2570	2	2005+
4	Quick Coupler (Male)	72F	HY-2535	1	2005+
5	Quick Coupler (Female)	72F	HY-2530	1	2005+
6	90 Degree Adapter	72F	HY-2520	6	2005+

**With quick couplers, the male end is usually the pressure in. On high-flow machines, however, the female is the pressure in.**





Fax Back 24-Hr Parts Order Form

Prices are subject to change without notice. Some parts may require different lengths for model specific applications.

## Parts Order Form-72F

Purchase Order Number \_\_\_\_\_

Dealership Name \_\_\_\_\_

Ship to Address \_\_\_\_\_

Contact Person \_\_\_\_\_

Telephone # \_\_\_\_\_ Fax # \_\_\_\_\_

<u>Part Number</u>	<u>Description</u>	<u>Retail Price</u>	<u>Quantity</u>
5"-EB	5" Weld Cap	\$34.85	_____
IP-145A	Idler Pulley	\$39.65	_____
CD-2150	Heavy Link	\$5.32	_____
CD-2100	Industrial Knife	\$1.82	_____
CD-2120	Std. Hanger	\$2.10	_____
CD-2135	Short Link	\$1.53	_____
RB-1700	Rubber Belting (Per ft.)	\$6.60	_____
TL-137	1 7/16" Retainer	\$23.10	_____
TL-139	1" Retainer	\$23.10	_____
P-123	Lower Pulley, 2 Groove	\$77.80	_____
P-124	Upper Pulley, 2 Groove	\$88.15	_____
B-155A	Banded Belt, 2 Groove	\$53.60	_____
CD-2116	1 7/16" Bearing, 4 Bolt	\$75.05	_____
BR-207	1 1/4" Bearing Assembly	\$83.50	_____
HY-2530	3/4" Female Quick Coupler	\$78.30	_____
HY-2535	3/4" Male Quick Coupler	\$44.35	_____
HY-2520	3/4" M ORB x 3/4" M JIC 90 Adapter	\$8.20	_____
HY-2525	3/4" M ORB x 3/4" M JIC 45 Adapter	\$11.60	_____
HY-2560	30" Hydraulic Hose	\$66.15	_____
HY-2570	72" Hydraulic Hose	\$90.05	_____
HY-2450	Motor Protection Valve	\$205.55	_____
DC-72F	Decal Set	\$29.95	_____
6902229	11.5 oz. Charcoal Spray Paint	\$10.91	_____

**Fax this completed form to (360) 230-2322.**

RockHound Attachments  
P.O. Box 220-2507 Tully Rd.  
Hughson, CA 95326  
Phone: (800) 426-5615 Fax: (360) 230-2322